

Type MLP 85 °C Flatpack, Ultra Long Life, Aluminum Electrolytic

Very Low Profile

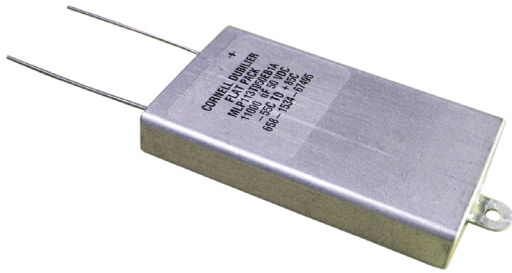

The MLP's high-energy storage and box-shape make it perfect for voltage holdup or filtering in military SEM-E modules, telecom circuit packs and computer cards. The MLP delivers up to 20 joules of energy storage in a 1/2" height with 50 year's life at +45 °C. You can readily heatsink it to double the ripple-current capability. The MLP is the square-peg component that fits the square-holes in electronic assemblies.

Highlights

- Low-profile replacement for snap-ins
- Double the ripple capability with a heatsink
- Nearly hermetic welded seal assures 50-year life
- Withstands more than 80,000 feet altitude

Specifications

Temperature Range	-55°C to +85°C ≤250 Vdc -40°C to +85°C ≥300 Vdc																																												
Rated Voltage Range	7.5 Vdc to 450 Vdc																																												
Capacitance Range	110 µF to 47,000 µF																																												
Capacitance Tolerance	±20%																																												
Leakage Current	≤ 0.002 CV µA, @ 25 °C and 5 min.																																												
Ripple Current Multipliers	<p>Ambient Temperature, No Heatsink</p> <table border="1"> <thead> <tr> <th>45 °C</th> <th>55 °C</th> <th>65 °C</th> <th>75 °C</th> <th>85 °C</th> </tr> </thead> <tbody> <tr> <td>1.00</td> <td>0.90</td> <td>0.75</td> <td>0.56</td> <td>0.27</td> </tr> </tbody> </table> <p>Case Temperature</p> <table border="1"> <thead> <tr> <th>45 °C</th> <th>55 °C</th> <th>65 °C</th> <th>75 °C</th> <th>85 °C</th> </tr> </thead> <tbody> <tr> <td>3.79</td> <td>3.32</td> <td>2.77</td> <td>2.08</td> <td>1.00</td> </tr> </tbody> </table> <p>Frequency</p> <table border="1"> <thead> <tr> <th></th> <th>50 Hz</th> <th>60 Hz</th> <th>120 Hz</th> <th>360 Hz</th> <th>1 kHz</th> <th>5 kHz</th> <th>10 kHz & up</th> </tr> </thead> <tbody> <tr> <th>7.5 to 63 V</th> <td>0.94</td> <td>0.95</td> <td>1.00</td> <td>1.04</td> <td>1.05</td> <td>1.06</td> <td>1.06</td> </tr> <tr> <th>80 to 450 V</th> <td>0.80</td> <td>0.85</td> <td>1.00</td> <td>1.17</td> <td>1.24</td> <td>1.28</td> <td>1.29</td> </tr> </tbody> </table>	45 °C	55 °C	65 °C	75 °C	85 °C	1.00	0.90	0.75	0.56	0.27	45 °C	55 °C	65 °C	75 °C	85 °C	3.79	3.32	2.77	2.08	1.00		50 Hz	60 Hz	120 Hz	360 Hz	1 kHz	5 kHz	10 kHz & up	7.5 to 63 V	0.94	0.95	1.00	1.04	1.05	1.06	1.06	80 to 450 V	0.80	0.85	1.00	1.17	1.24	1.28	1.29
45 °C	55 °C	65 °C	75 °C	85 °C																																									
1.00	0.90	0.75	0.56	0.27																																									
45 °C	55 °C	65 °C	75 °C	85 °C																																									
3.79	3.32	2.77	2.08	1.00																																									
	50 Hz	60 Hz	120 Hz	360 Hz	1 kHz	5 kHz	10 kHz & up																																						
7.5 to 63 V	0.94	0.95	1.00	1.04	1.05	1.06	1.06																																						
80 to 450 V	0.80	0.85	1.00	1.17	1.24	1.28	1.29																																						
Low Temperature Characteristics	Impedance ratio: $Z_{-55^{\circ}\text{C}}/Z_{+25^{\circ}\text{C}}$ ≤ 10 (7.5 - 20 Vdc) ≤ 2 (25 - 250 Vdc) Impedance ratio: $Z_{-20^{\circ}\text{C}}/Z_{+25^{\circ}\text{C}}$ ≤ 4 (300-450Vdc)																																												
Endurance Life Test	2000 h @ full load at +85 °C Δ Capacitance ±10% ESR 200% of limit DCL 100% of limit																																												
Shelf Life Test	500 h at 85 °C Capacitance 100% of limit ESR 100% of limit DCL 100% of limit																																												
Vibration	All case sizes: 10g. MIL-STD-202, Meth. 204, Sine Swept, EIEC 60068-2-6																																												

Type MLP 85 °C Flatpack, Ultra Long Life, Aluminum Electrolytic

Very Low Profile

Vibration Test	<p>Level The specimens, while deenergized or operating under the load conditions specified, shall be subjected to the vibration amplitude, frequency range, and duration specified for each case size.</p> <p>Amplitude The specimens shall be subjected to a simple harmonic motion having an amplitude of either 0.06-inch double amplitude (maximum total excursion) or peak level specified above (XXg peak), whichever is less. The tolerance on vibration amplitude shall be ±10 percent.</p> <p>Frequency Range The vibration frequency shall be varied logarithmically between the approximate limits of 10 to 2,000 Hz.</p> <p>Sweep Time and Duration The entire frequency range of 10 to 2,000 Hz and return to 10 Hz shall be traversed in 20 minutes. This cycle shall be performed 12 times in each of three mutually perpendicular directions (total of 36 times), so that the motion shall be applied for a total period of approximately 12 hours. Interruptions are permitted provided the requirements for rate of change and test duration are met.</p>																											
Thermal Resistance	<table border="1" data-bbox="769 728 1516 976"> <thead> <tr> <th rowspan="2">Large Sides Heatsinked</th> <th rowspan="2">Case Length</th> <th>1.5"</th> <th>2.0"</th> <th>3.0"</th> </tr> <tr> <th>Insulation</th> <th>°C/W</th> <th>°C/W</th> <th>°C/W</th> </tr> </thead> <tbody> <tr> <td rowspan="2">one</td> <td>None</td> <td>2.9</td> <td>2.1</td> <td>1.4</td> </tr> <tr> <td>Polyester</td> <td>3.3</td> <td>2.4</td> <td>1.6</td> </tr> <tr> <td rowspan="2">both</td> <td>None</td> <td>2.7</td> <td>1.9</td> <td>1.2</td> </tr> <tr> <td>Polyester</td> <td>2.9</td> <td>2.1</td> <td>1.3</td> </tr> </tbody> </table>	Large Sides Heatsinked	Case Length	1.5"	2.0"	3.0"	Insulation	°C/W	°C/W	°C/W	one	None	2.9	2.1	1.4	Polyester	3.3	2.4	1.6	both	None	2.7	1.9	1.2	Polyester	2.9	2.1	1.3
Large Sides Heatsinked	Case Length			1.5"	2.0"	3.0"																						
		Insulation	°C/W	°C/W	°C/W																							
one	None	2.9	2.1	1.4																								
	Polyester	3.3	2.4	1.6																								
both	None	2.7	1.9	1.2																								
	Polyester	2.9	2.1	1.3																								
ESL	<30 nH measured 1/4" from case at 1 MHz																											
Weight	Case EK 30 g typical Case EA 42 g typical Case EB 66 g typical																											
Terminals	18 AWG copper wire with 60/40 tin-lead electroplate, 20 amps max																											
Double the Ripple Current	Attach the MLP to an external heatsink and you can easily double the ripple current capability and assure long life through cooler operation. The broad, flat top and bottom on the MLP are ideal for cooling the capacitor and removing the heat caused by ripple current.																											
Ripple Current Capability	The ripple current capability is set by the maximum permissible internal core temperature, 88 °C. This assures that the case does not inflate beyond 0.5 inch height.																											
Air Cooled	The ripple currents in the ratings tables are for 85 °C case temperatures. For air temperatures without a heatsink use the multipliers Ambient Temperature, No Heatsink.																											
Heatsink Cooled	Temperature rise from the internal hottest spot, the core, to ambient air is $\Delta T = I^2(ESR)(\theta_{cc} + \theta_{ca})$ where θ_{cc} is the thermal resistance from core to case and θ_{ca} from case to ambient. To calculate maximum ripple capability with the MLP attached to a heatsink use the maximum core temperature and the values for θ_{cc} .																											
Example	As an illustration, suppose you operate an insulated MLP332M080EB1C in 65 °C air and attach it to a commercial heatsink with a free-air thermal resistance of 2.7 °C/W. Use a good thermal grease between the MLP and the heatsink, and the total thermal resistance is 2.7 + 1.7 or 4.4 °C/W. The power which would heat the core to 88 °C is (88-65)/4.4 or 5.2 W. For an ESR of 31 mΩ, 5.2 W equates to a ripple current of 13 A.																											

Type MLP 85 °C Flatpack, Ultra Long Life, Aluminum Electrolytic

Very Low Profile

Part Numbering System

MLP Type MLP	102 Capacitance 821=820 μ F 102 = 1000 μ F	M Tolerance M=±20%	200 Rated Voltage Vdc	EB Case Code EK, L=1.5 in. EA, L=2.0 in. EB, L=3.0 in.	0 Insulation 0 = bare can 1 = polyester	A Mounting Style A = mounting tabs B = four leads C = two leads/no tabs D = hook leads/tabs E = hook leads/no tabs
-------------------------	--	-------------------------------	----------------------------------	---	---	---

Outline Drawings

Note: The polyester tape wrap may add up to 0.020 inches to the thickness and width of the capacitor.

Style A: Mounting Tabs

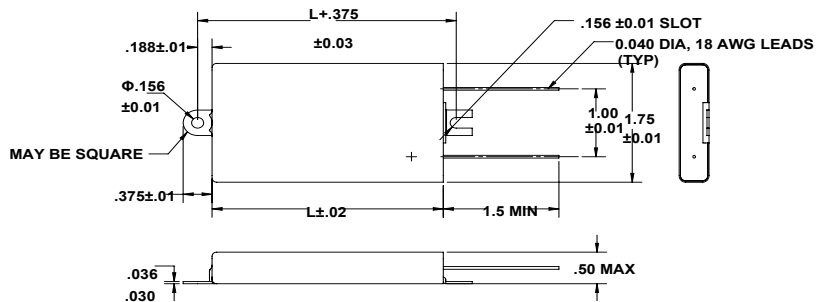

Mounting tabs and negative lead are welded to the case.

Style B: Four Leads

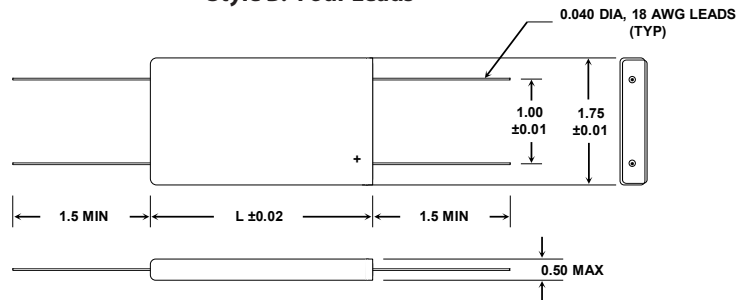

Three negative leads are welded to the case.

Style C: No Tabs

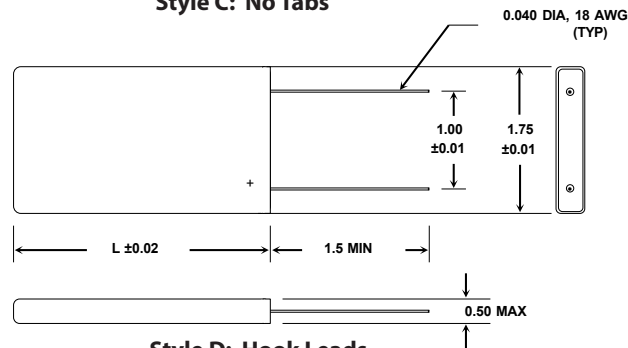

The negative lead is welded to the case.

Style D: Hook Leads

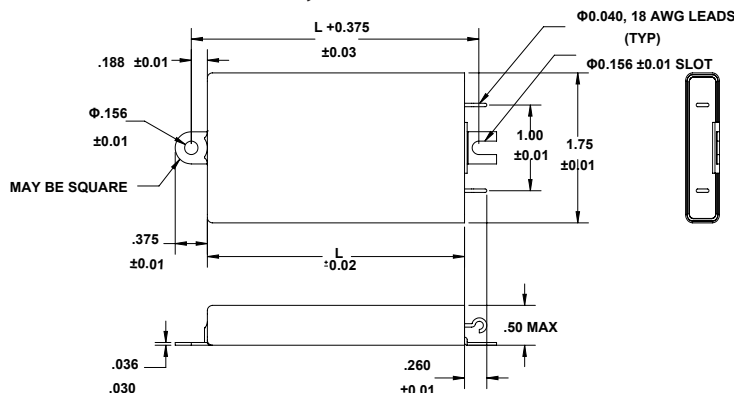

Mounting tabs and negative lead are welded to the case.

Case Code	Length L (in)	Weight (g)
EK	1.5	30
EA	2.0	42
EB	3.0	66

Type MLP 85 °C Flatpack, Ultra Long Life, Aluminum Electrolytic

Very Low Profile

Ratings

Cap. (µF)	Catalog Part Number	ESR max 25 °C (mΩ)		Ripple (A) Case @ 85 °C		Length (Inches)
		120 Hz	20 kHz	120 Hz	20 kHz	
7.5 Vdc (10 Vdc Surge)						
19,000	MLP193M7R5EK0A	76	66	4.2	4.5	1.5
28,000	MLP283M7R5EA0A	50	44	5.8	6.2	2.0
47,000	MLP473M7R5EB0A	30	26	9.1	9.8	3.0
10 Vdc (13 Vdc Surge)						
17000	MLP173M010EK0A	77	67	4.2	4.5	1.5
26000	MLP263M010EA0A	51	45	5.8	6.1	2.0
43000	MLP433M010EB0A	30	27	9.0	9.6	3.0
16 Vdc (20 Vdc Surge)						
13000	MLP133M016EK0A	81	69	4.1	4.4	1.5
21000	MLP213M016EA0A	53	46	5.7	6.1	2.0
38000	MLP383M016EB0A	31	27	9.0	9.6	3.0
20 Vdc (25 Vdc Surge)						
9600	MLP962M020EK0A	84	69	4.0	4.4	1.5
14000	MLP143M020EA0A	56	46	5.5	6.1	2.0
24000	MLP243M020EB0A	33	27	8.7	9.6	3.0
25 Vdc (30 Vdc Surge)						
8000	MLP802M025EK0A	87	69	3.9	4.4	1.5
12000	MLP123M025EA0A	57	46	5.5	6.1	2.0
20000	MLP203M025EB0A	34	27	8.6	9.6	3.0
35 Vdc (50 Vdc Surge)						
5600	MLP562M035EK0A	90	70	3.4	4.4	1.5
8400	MLP842M035EA0A	59	46	5.4	6.1	2.0
14000	MLP143M035EB0A	35	27	8.4	9.6	3.0
50 Vdc (63 Vdc Surge)						
4400	MLP442M050EK0A	97	70	3.7	4.4	1.5
6600	MLP662M050EA0A	62	46	5.2	6.1	2.0
11000	MLP113M050EB0A	36	27	8.3	9.6	3.0
63 Vdc (75 Vdc Surge)						
2200	MLP222M063EK0A	101	76	3.7	4.2	1.5
3300	MLP332M063EA0A	64	50	5.2	5.8	2.0
5600	MLP562M063EB0A	36	29	8.3	9.3	3.0
80 Vdc (100 Vdc Surge)						
1500	MLP152M080EK0A	106	77	3.6	4.2	1.5
2100	MLP212M080EA0A	72	52	4.9	5.7	2.0
3300	MLP332M080EB0A	44	31	7.5	9.0	3.0

Cap. (µF)	Catalog Part Number	ESR max 25 °C (mΩ)		Ripple (A) Case @ 85 °C		Length (Inches)
		120 Hz	20 kHz	120 Hz	20 kHz	
100 Vdc (125 Vdc Surge)						
1100	MLP112M100EK0A	112	78	3.5	4.2	1.5
1600	MLP162M100EA0A	76	54	4.7	5.6	2.0
2700	MLP272M100EB0A	46	33	7.4	8.7	3.0
150 Vdc (180 Vdc Surge)						
500	MLP501M150EK0A	355	248	1.9	2.3	1.5
770	MLP771M150EA0A	238	166	2.7	3.2	2.0
1300	MLP132M150EB0A	143	100	4.2	5.0	3.0
200 Vdc (250 Vdc Surge)						
400	MLP401M200EK0A	388	253	1.9	2.3	1.5
600	MLP601M200EA0A	261	168	2.6	3.2	2.0
1000	MLP102M200EB0A	158	100	3.8	5.0	3.0
250 Vdc (300 Vdc Surge)						
330	MLP331M250EK0A	426	258	1.8	2.3	1.5
490	MLP491M250EA0A	285	172	2.4	3.1	2.0
820	MLP821M250EB0A	172	103	3.8	4.9	3.0
300 Vdc (350 Vdc Surge)						
220	MLP221M300EK0A	597	393	1.5	1.9	1.5
330	MLP331M300EA0A	399	262	2.1	2.5	2.0
560	MLP561M300EB0A	240	157	3.2	4.0	3.0
350 Vdc (400 Vdc Surge)						
150	MLP151M350EK0A	1000	734	1.2	1.4	1.5
220	MLP221M350EA0A	683	503	1.6	1.8	2.0
370	MLP371M350EB0A	420	310	2.3	2.8	3.0
400 Vdc (450 Vdc Surge)						
130	MLP131M400EK0A	1320	970	1.0	1.2	1.5
200	MLP201M400EA0A	882	648	1.4	1.6	2.0
330	MLP331M400EB0A	530	390	2.1	2.5	3.0
420 Vdc (475 Vdc Surge)						
130	MLP131M420EK0A	1320	970	1.0	1.2	1.5
200	MLP201M420EA0A	882	648	1.4	1.6	2.0
330	MLP331M420EB0A	530	390	2.1	2.5	3.0
450 Vdc (500 Vdc Surge)						
110	MLP111M450EK0A	1456	1190	0.96	1.1	1.5
170	MLP171M450EA0A	973	797	1.3	1.5	2.0
280	MLP281M450EB0A	585	480	2.0	2.3	3.0

Typical Performance Curves

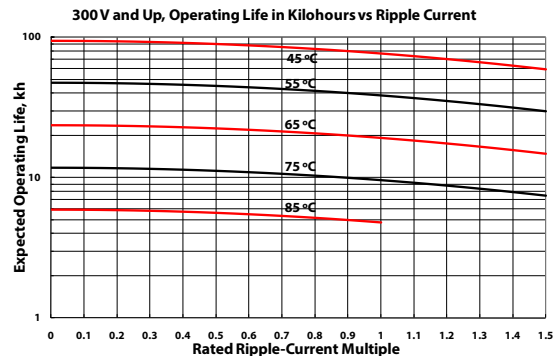

Type MLP 85 °C Flatpack, Ultra Long Life, Aluminum Electrolytic

Very Low Profile

Typical Performance Curves

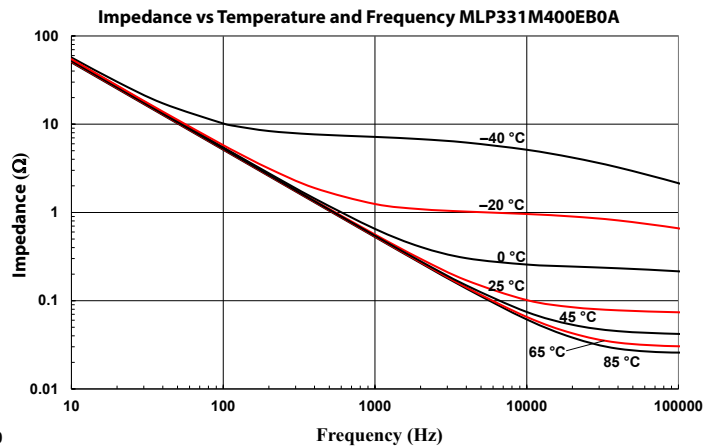
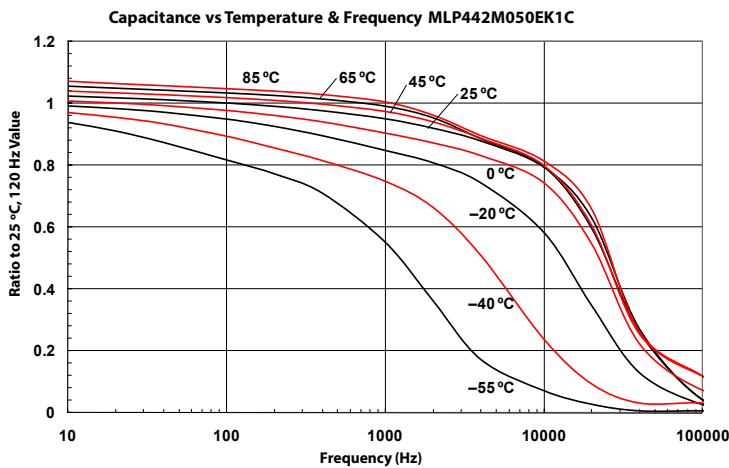
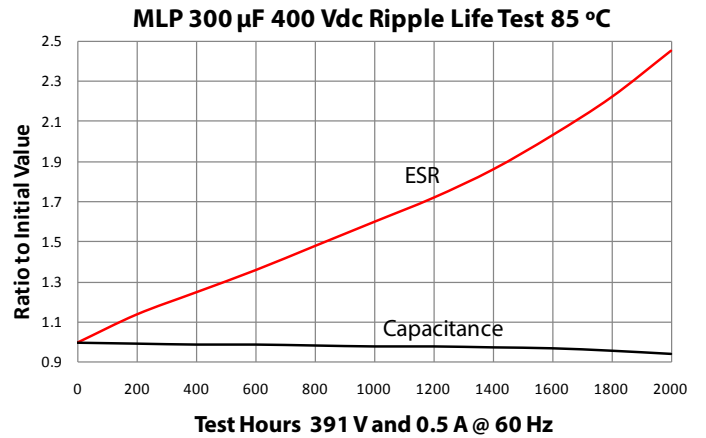
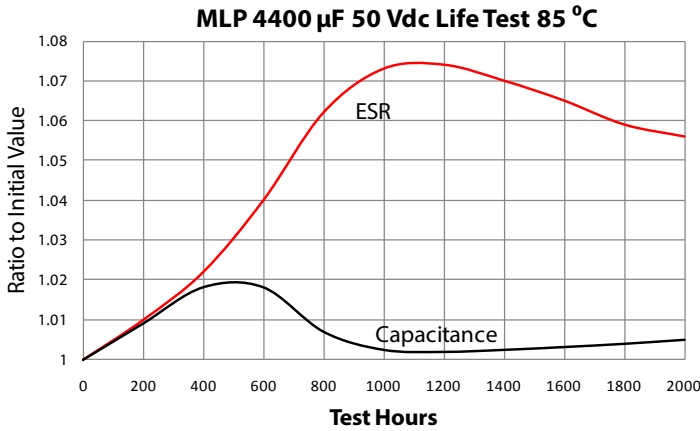
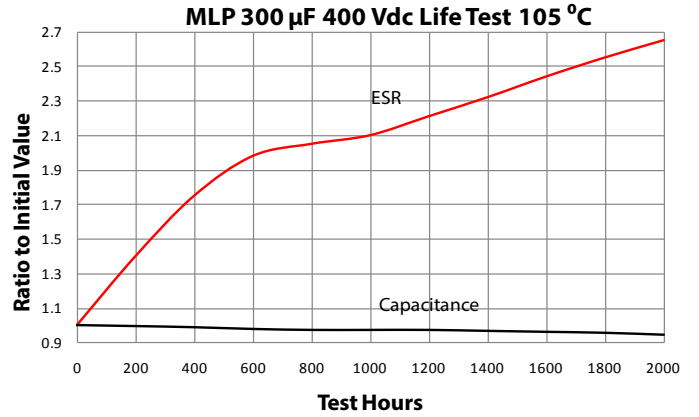
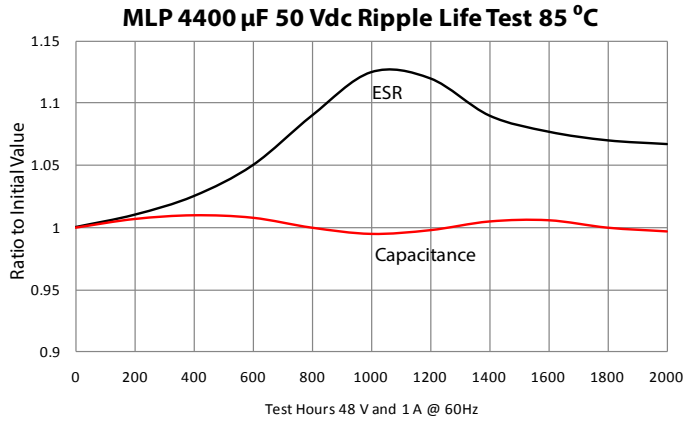

Notice and Disclaimer: All product drawings, descriptions, specifications, statements, information and data (collectively, the "Information") in this datasheet or other publication are subject to change. The customer is responsible for checking, confirming and verifying the extent to which the Information contained in this datasheet or other publication is applicable to an order at the time the order is placed. All Information given herein is believed to be accurate and reliable, but it is presented without any guarantee, warranty, representation or responsibility of any kind, expressed or implied. Statements of suitability for certain applications are based on the knowledge that the Cornell Dubilier company providing such statements ("Cornell Dubilier") has of operating conditions that such Cornell Dubilier company regards as typical for such applications, but are not intended to constitute any guarantee, warranty or representation regarding any such matter – and Cornell Dubilier specifically and expressly disclaims any guarantee, warranty or representation concerning the suitability for a specific customer application, use, storage, transportation, or operating environment. The Information is intended for use only by customers who have the requisite experience and capability to determine the correct products for their application. Any technical advice inferred from this Information or otherwise provided by Cornell Dubilier with reference to the use of any Cornell Dubilier products is given gratis (unless otherwise specified by Cornell Dubilier), and Cornell Dubilier assumes no obligation or liability for the advice given or results obtained. Although Cornell Dubilier strives to apply the most stringent quality and safety standards regarding the design and manufacturing of its products, in light of the current state of the art, isolated component failures may still occur. Accordingly, customer applications which require a high degree of reliability or safety should employ suitable designs or other safeguards (such as installation of protective circuitry or redundancies or other appropriate protective measures) in order to ensure that the failure of an electrical component does not result in a risk of personal injury or property damage. Although all product-related warnings, cautions and notes must be observed, the customer should not assume that all safety measures are indicated in such warnings, cautions and notes, or that other safety measures may not be required.